



ISP Parts Information

Quick Guide

ISP Parts Information Product Management – August 2019

Mercedes-Benz

Das Beste oder nichts.



ISP Parts Information provides optimal support for part searches.

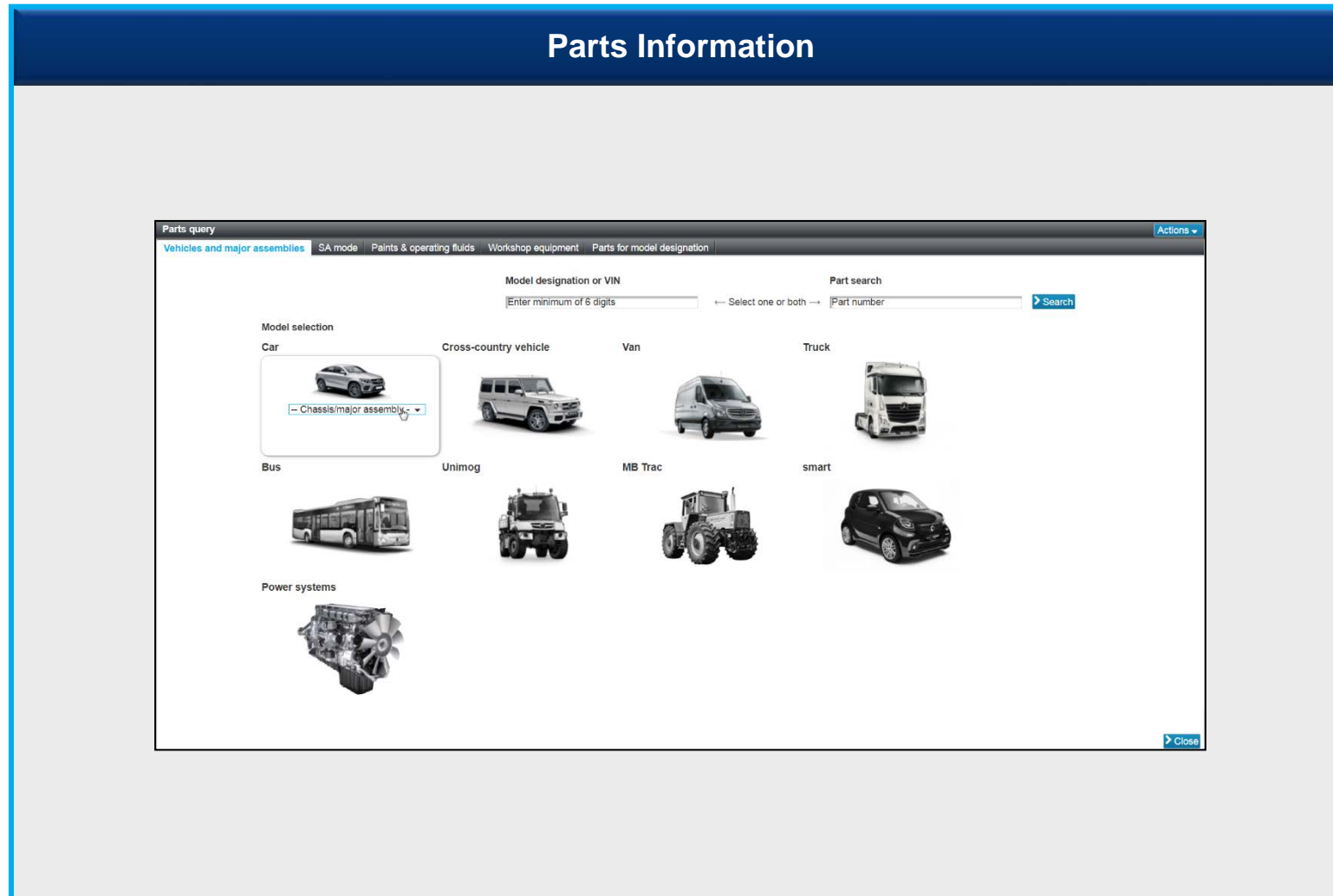

Overview of Parts Information

ISP Parts Information, the innovative solution for parts research, is an efficient and clearly structured resource providing you with vehicle-relevant and job-relevant information.

- Parts kits are displayed to provide you with a quick overview of which parts are contained in each kit.

This document provides you with a quick overview of the **Parts Information** function and is intended to help you get started with a more convenient way of working.

Link : <https://aftersales.i.daimler.com/>

Language settings

The screenshot shows the Daimler After-Sales Platform interface. At the top left is the Daimler logo, and at the top right is the text "After-Sales Platform". Below this is a navigation bar with "Daimler AG", "English" (with a dropdown arrow), and the date "11.10.2018". A "Welcome" banner is visible on the left. A sidebar menu on the left contains the following items: Home, Personal data, Language settings (highlighted), Password question, Change password, Support Information, and Logout. The main content area is titled "Language settings" and contains three sections: "Application language", "Content languages", and "Help languages". Each section has three rows: "Preferred", "Second", and "Additional", each with a dropdown menu. The "Preferred" dropdown in all sections is currently set to "en". A "Save" button is located at the bottom left of the settings area. At the bottom right, there is a release version "Release: 2.1.3.0 (P1-2)" and a copyright notice: "Copyright: 1998-2017 Daimler AG. All rights reserved. Provider, Legal Notices and Terms, Privacy Statement".

Defining the language:

If your preferred language is not set, you can change the language under Language settings.

Contents

No.	Topic	Page
1.	Access and determining vehicle.....	6
2.	Parts Information – Researching parts.....	8
3.	Selecting main groups and subgroups.....	9
4.	Picture chart.....	11
5.	Parts list and availability display for parts.....	12
6.	Detailed information on item number.....	13
7.	Additional information on vehicle and notes.....	17
8.	Search function.....	20
9.	Printing out labels for special tools.....	26
10.	Overview of user settings.....	27
11.	Recording of faults and requirements.....	28

Accessing ISP Parts Information from the After-Sales platform

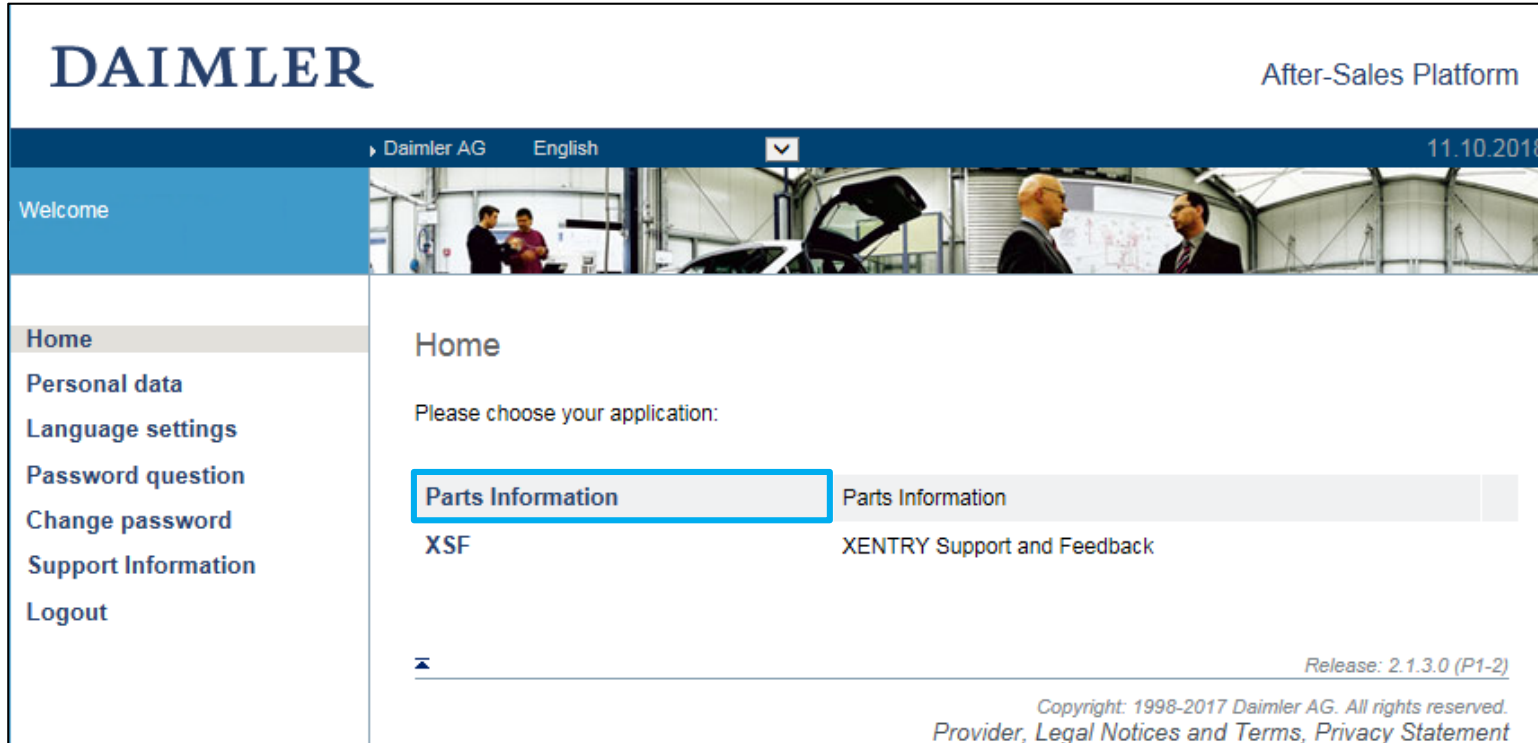

Select the ISP Parts Information application. Clicking on it takes you directly to the search screen.

Starting point in XENTRY Parts Information - Defining the vehicle

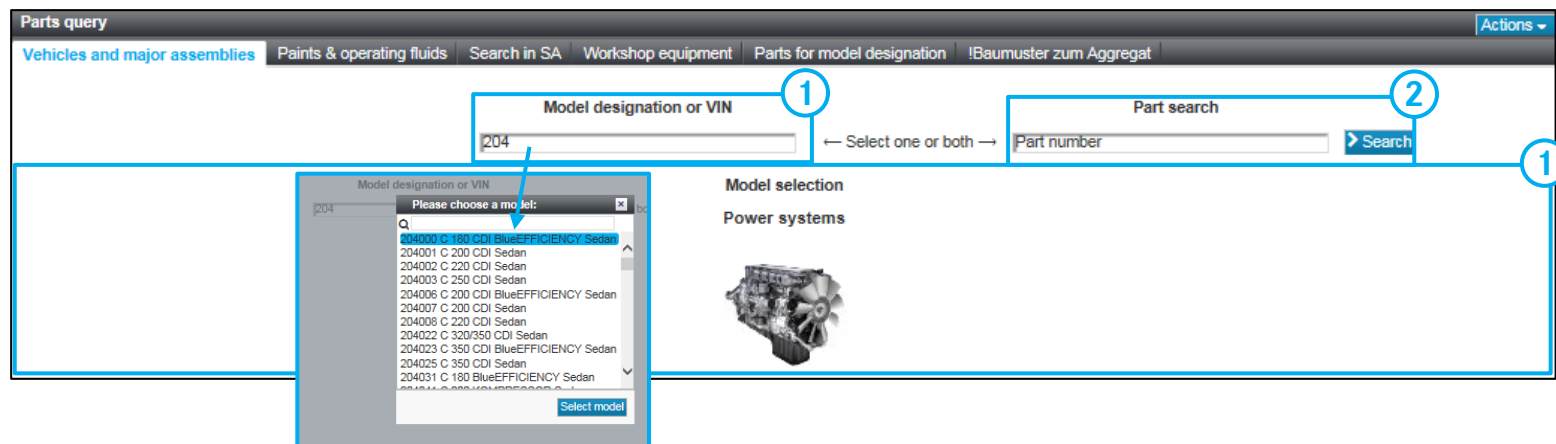

Note: You can reactivate the view with the full view in your user preferences.

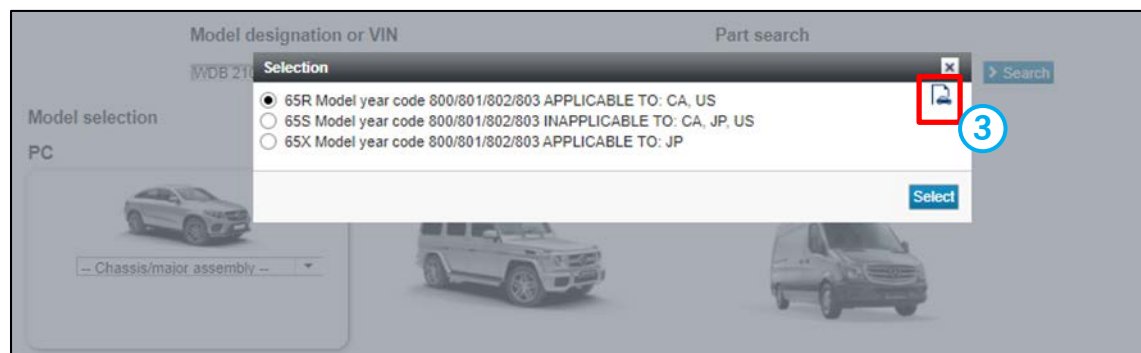

Note: It is also possible to search by entering the last 8 digits of a FIN/VIN!

① Vehicle definition:

You can define a specific vehicle by entering the **FIN/VIN** (vehicle identification number). When the **Search** button is pressed, the VIN is checked for validity so that vehicle-specific parts are displayed. Defining a specific vehicle considerably simplifies the identification of parts.

Alternatively, you can define the vehicle manually by entering the three-digit **model series/model designation** or by selecting the **model**.

Now you can begin to search for parts.

② Part search

③ The **data card** can be called up when selecting the catalog.

Overview of Parts Information

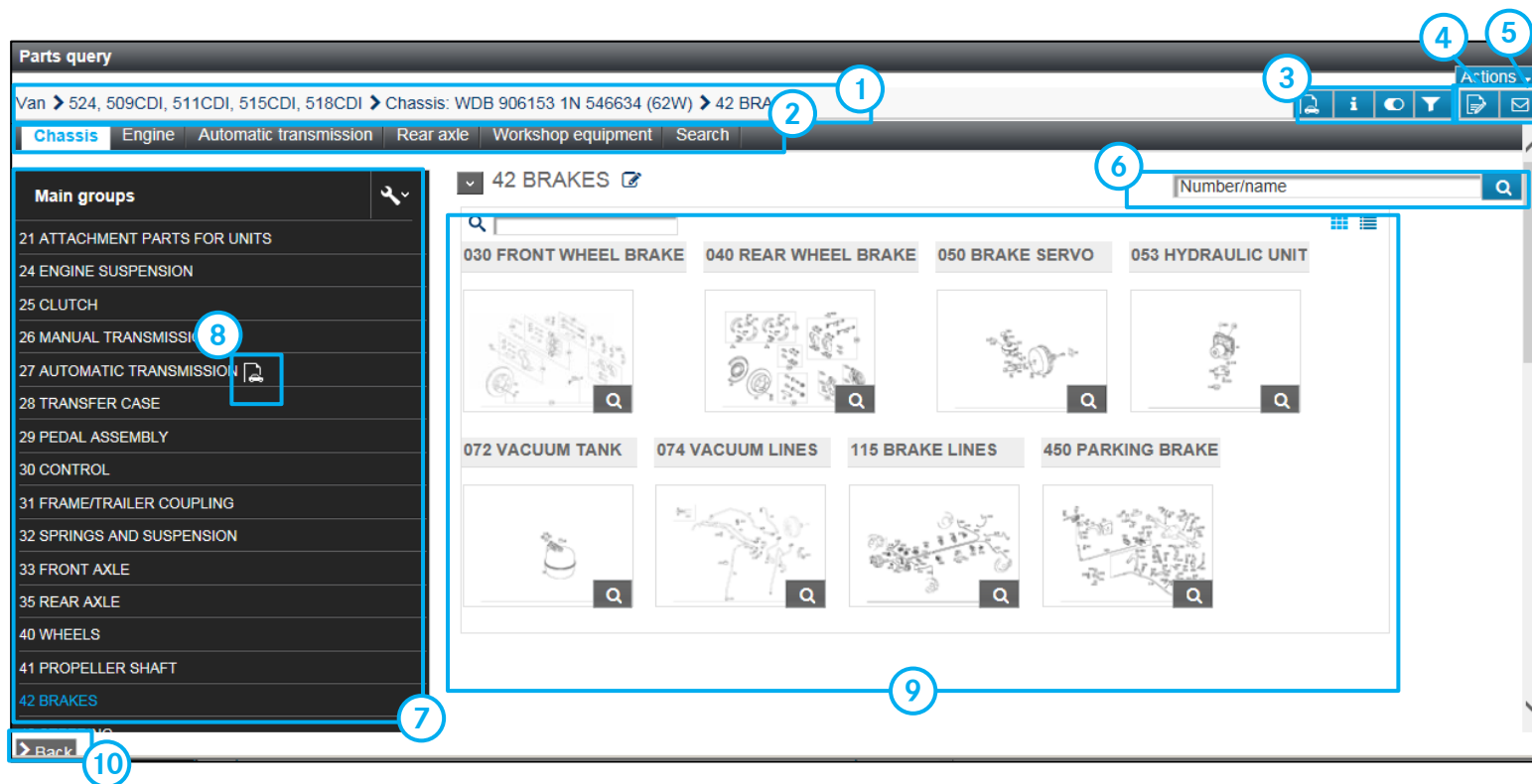

- 1 Dynamic navigation path
- 2 Search options by various categories
- 3 Selection of information, e.g. data card, filter settings etc., and the option to change the search context between FIN/VIN and model designation
- 4 Display all created notes
- 5 Create XSF Ticket for Parts Information
- 6 Simple search/callup by direct entry of part number/designation or main group/subgroup etc.
- 7 Overview of main groups
- 8 Clicking on this symbol opens the data card with the FO texts
- 9 When a main group is selected, the subgroups belonging to it are displayed
- 10 The Back button takes you back to the home screen with the vehicle definition, where you can launch a new part search.

Display of SAs in main groups

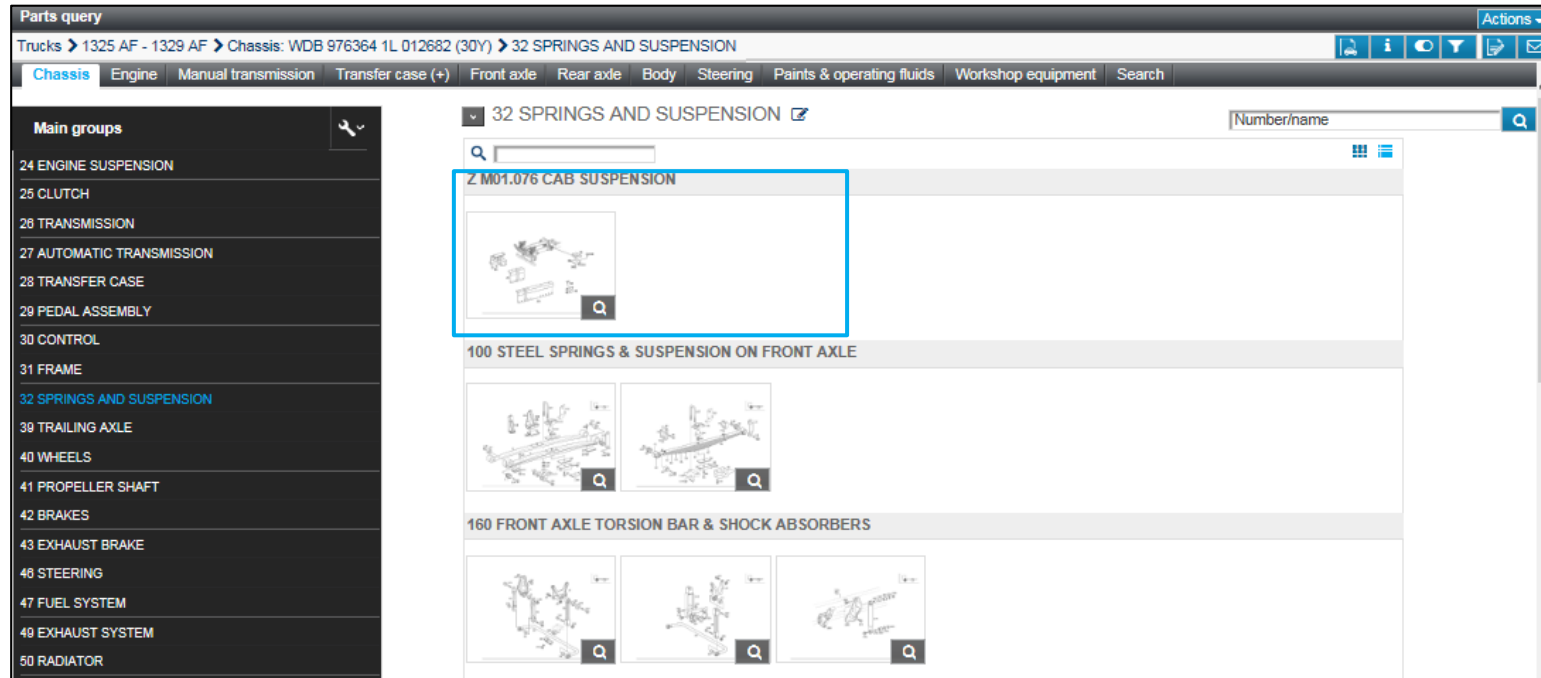

Optimized display of SAs in main groups

If a main group contains SAs, these are displayed at the beginning of the list with the other subgroups underneath.

Selecting a subgroup

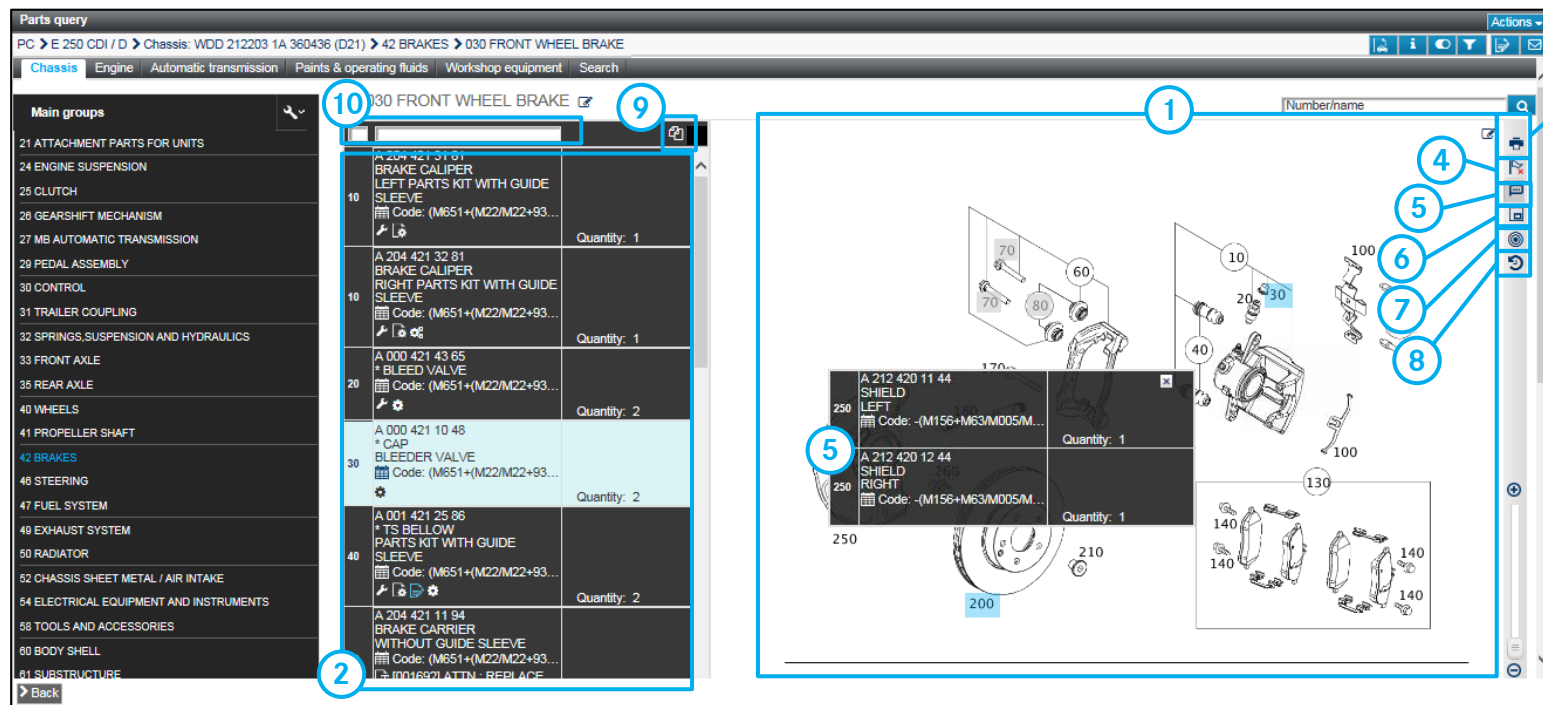

- 1 **Picture chart**
The picture contains a graphic representation of the parts with sensitive item numbers. Clicking on one or more item numbers highlights the corresponding part numbers in the parts list.
- 2 **Flyout list**
- 3 **Print picture chart/parts list/highlighted parts only**
- 4 **Deselect all item numbers**
The symbol deselects all the clicked item numbers in the picture.
- 5 **Hide/show details**
Note: When active: Details are displayed
Deactivated: Several parts can be quickly selected, highlighted and placed in the shopping cart with one click.
- 6 **Hide/show zoom info**
- 7 **Show/hide non-highlighted parts**
- 8 **Show/hide replaced parts**
- 9 **Copy highlighted parts to clipboard**
- 10 **Filter option in parts list preview**

4. The picture chart

Picture chart

Parts query
PC > E 250 CDI / D > Chassis: 212203 1A 360436 > 42 BRAKES > 030 FRONT WHEEL BRAKE

Item No.	Description	Code	Quantity
10	A 204 421 31 81 BRAKE CALIPER LEFT PARTS KIT WITH GUIDE SLEEVE	Code: (M651+(M22/M22+93...	Quantity: 1
10	A 204 421 32 81 BRAKE CALIPER RIGHT PARTS KIT WITH GUIDE SLEEVE	Code: (M651+(M22/M22+93...	Quantity: 1
20	A 000 421 43 65 * BLEED VALVE	Code: (M651+(M22/M22+93...	Quantity: 2
30	A 000 421 10 48 * CAP BLEEDER VALVE	Code: (M651+(M22/M22+93...	Quantity: 2
40	A 001 421 25 86 * TS BELLOW PARTS KIT WITH GUIDE SLEEVE	Code: (M651+(M22/M22+93...	Quantity: 2
60	A 204 421 11 94 BRAKE CARRIER WITHOUT GUIDE SLEEVE	Code: (M651+(M22/M22+93...	Quantity: 2

Image ID: drawing_B42030000138

42 BRAKES

030 FRONT WHEEL BRAKE

060 BRAKE BOOST...

064 HYDRAULIC U...

090 BRAKE LINES

145 FOOT OPERAT...

- 1 Select item numbers**
The item numbers in the picture are clickable fields. When the cursor is on an item number, it is surrounded by green border and the detailed information opens.
- 2 Detailed information on selected item number.** This opens automatically if the cursor is moved over the item number.
- 3 Highlight item number**
Once you have highlighted the item number in the detailed information by clicking on it, it is also shown in blue on the picture chart.
- 4 Gray item numbers are not valid for the vehicle.**
- 5 Zoom in/zoom out**
Gradually enlarge/reduce size of picture
- 6 Subgroup**
- 7 Enlarged miniature view of subgroup**
- 8 Copy part number**

5. The parts list

Parts list

Parts query

PKW > E 250 CDI / D > Chassis: 212203 1A 360436 > 42 BRAKES > 030 FRONT WHEEL BRAKE

84 REAR END

85 ROOF

87 WINDOWS

88 PANELLING

89 COVERING AND LINING

72 FRONT DOORS

73 REAR DOORS

74 REAR-END DOOR

78 SLIDING ROOF

80 VACUUM SYSTEM / HYDRAULIC SYSTEM

82 ELECTRICAL SYSTEM

83 HEATING AND VENTILATION

84 TRUNKS AND CASES

86 WINDSHIELD WASHER, EMERGENCY EQUIPMT.

88 ATTACHMENT PARTS

91 DRIVER'S SEAT

92 REAR SEAT BENCH

93 FOLDING SEAT / CENTER SEAT

98 ACCESSORIES

99 SPECIAL EQUIPMENT

Parts for selection

Item	Part number	Designation/additional information	Qty
> 10	A 204 421 31 81	BRAKE CALIPER LEFT PARTS KIT WITH GUIDE SLEEVE Fault location 42B03 Show plant information Code: (M651+(M22/M22+937)+(M014/M014+ME04))+M005;	1
> 10	A 204 421 32 81	BRAKE CALIPER RIGHT PARTS KIT WITH GUIDE SLEEVE Fault location 42P03 Show plant information Code: (M651+(M22/M22+937)+(M014/M014+ME04))+M005;	1
> 20	A 000 421 43 65	* BLEEDER VALVE Fault location 42118 Code: (M651+(M22/M22+937)+(M014/M014+ME04))+M005;	2
> 30	A 000 421 10 48	* CAP BLEEDER VALVE Code: (M651+(M22/M22+937)+(M014/M014+ME04))+M005;	2
> 40	A 001 421 25 86	* TS BELLOW PARTS KIT WITH GUIDE SLEEVE Fault location 42113 Show plant information Code: (M651+(M22/M22+937)+(M014/M014+ME04))+-(M005/1U9);	2
> 60	A 204 421 11 94	BRAKE CARRIER WITHOUT GUIDE SLEEVE Fault location 42125 Show plant information Code: (M651+(M22/M22+937)+(M014/M014+ME04))+M005; [001692] ATTN.: REPLACE FASTENERS/NOTE WORKSHOP LITERATURE	2
> 100	A 000 993 46 07	RETAINING SPRING Fault location 42116	2

Back

- 1 **Parts list**
The parts list is located under the picture chart.
- 2 **Part designation, possibly with additional information**
- 3 **Copy part number**
- 4 **Selected item numbers** from the picture chart are highlighted in blue in the parts list.

Detailed information on item number

Code/SA/Installation kit information

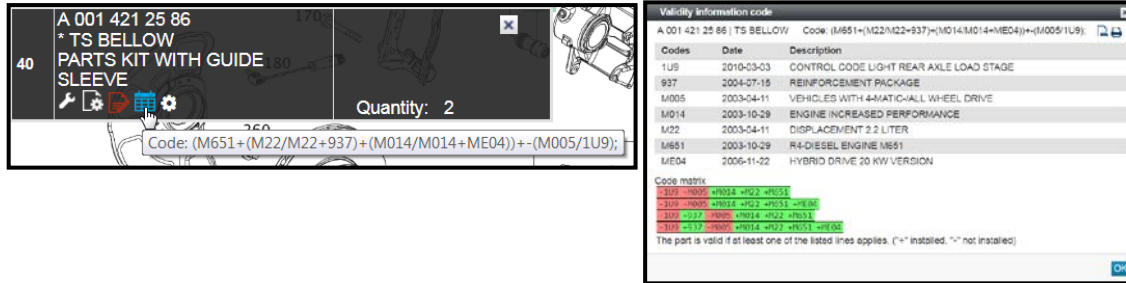

Clicking the icon **inside the picture chart** or in the **parts list** displays further information in a dialog box. The icon is valid for:

- Code information (cars)
- Special equipment/component information (commercial vehicles)
- Modular system information (buses)

Text footnote

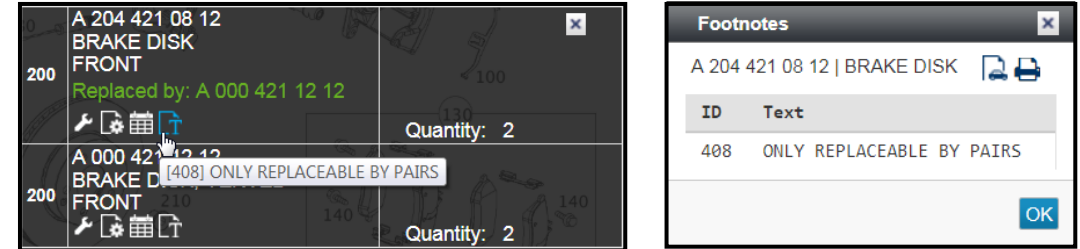

Text footnotes provide important information which must be taken into account during part selection. This symbol represents a **note**.

Footnote on validity

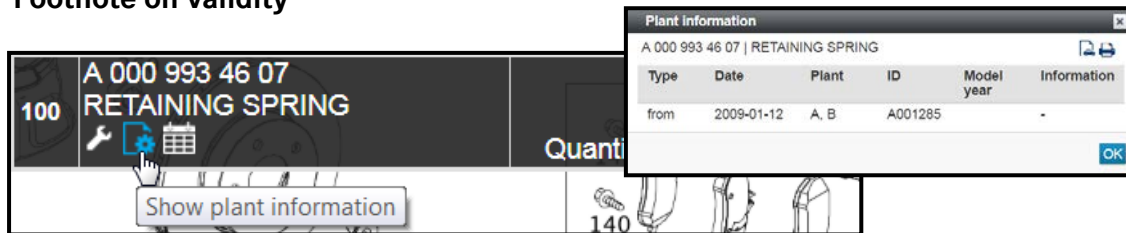

Validity footnotes display installability information.

Display of data card in dialog windows

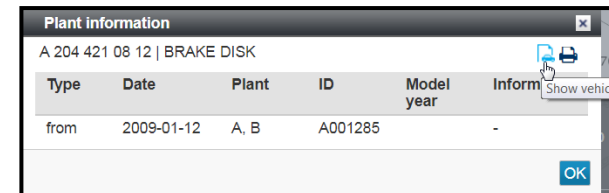

Clicking on **Show Vehicle** opens the **data card** of the vehicle in a new window.

Detailed information on item number

Display of designations for included ancillary parts

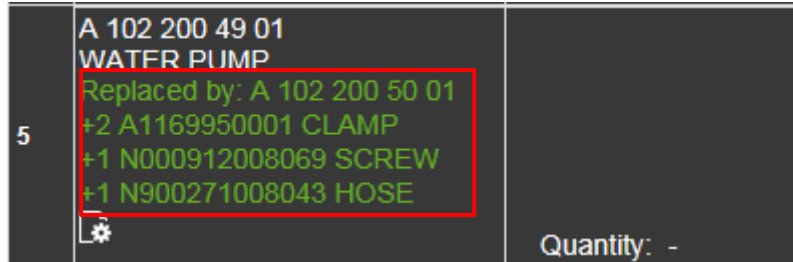

In the case of included ancillary parts, the associated designations are displayed.

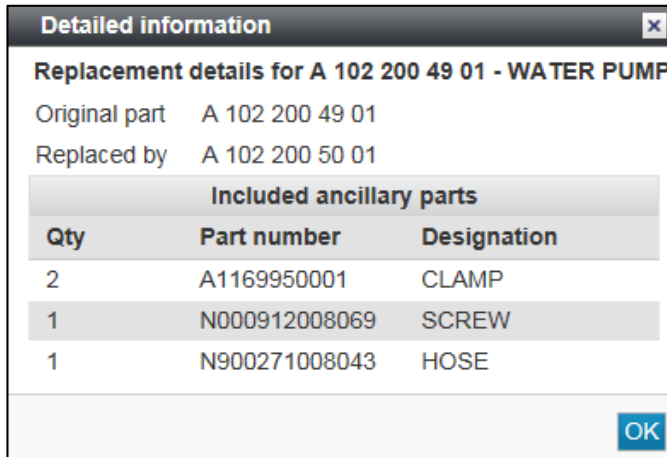

Display of model designation validities in the parts list

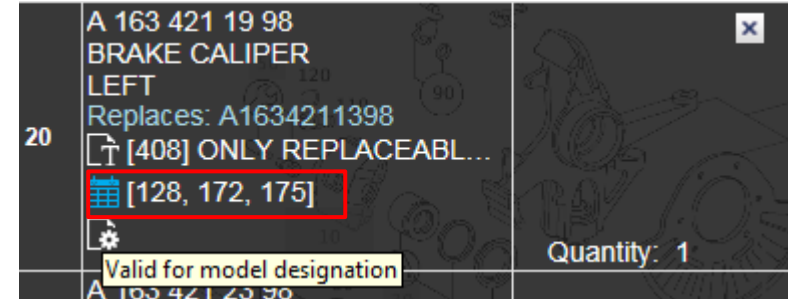

In the case of parts that are valid for several model designations, the model designation validities are immediately displayed in the parts list. This function is available when starting with a model designation or when the filters are deactivated.

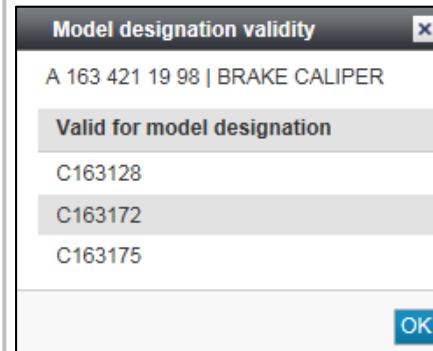

Detailed information on item number - Display of parts kit for part

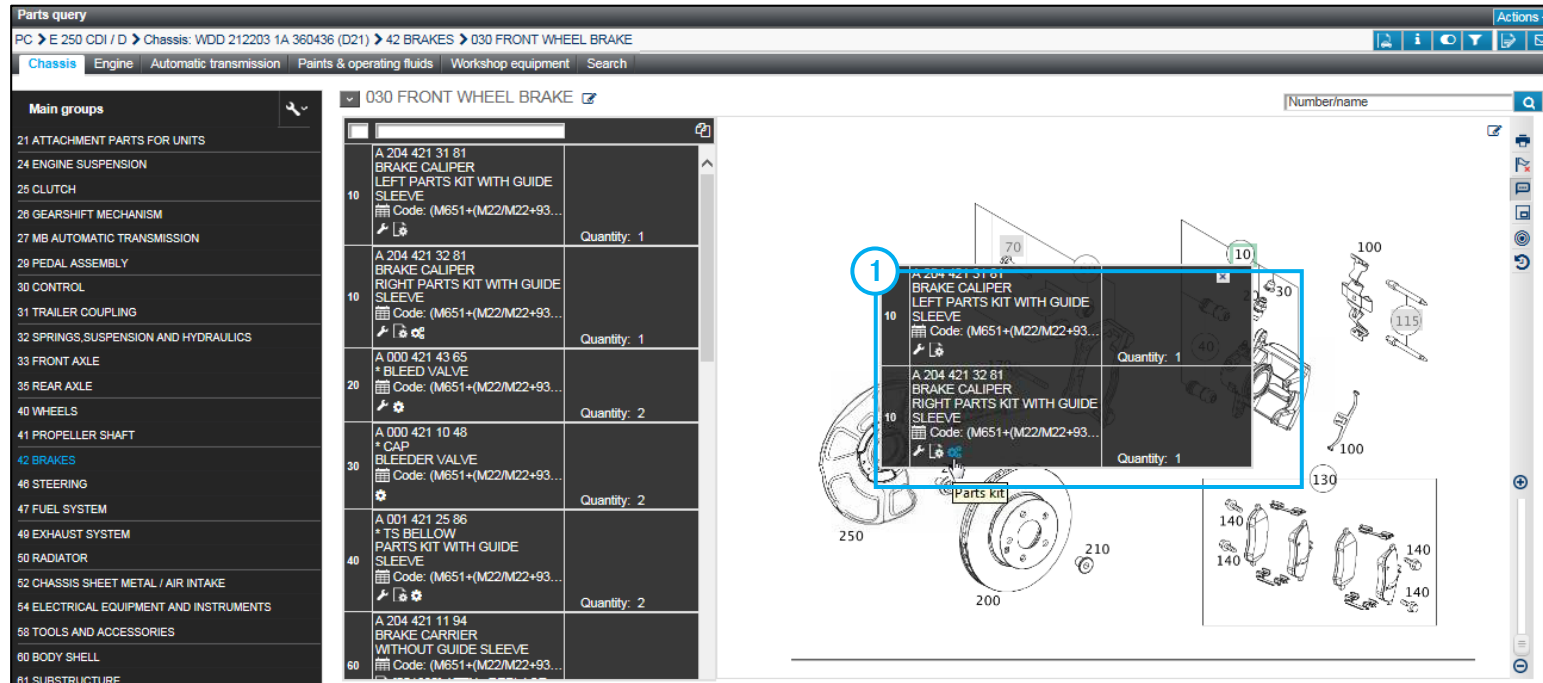

1

Select parts kit

A parts kit (package contents) contains all "asterisk" items which are listed under a part item without asterisk (e.g. item 10).

2

Parts kit details

Quick overview of which parts are contained in a parts kit.

2

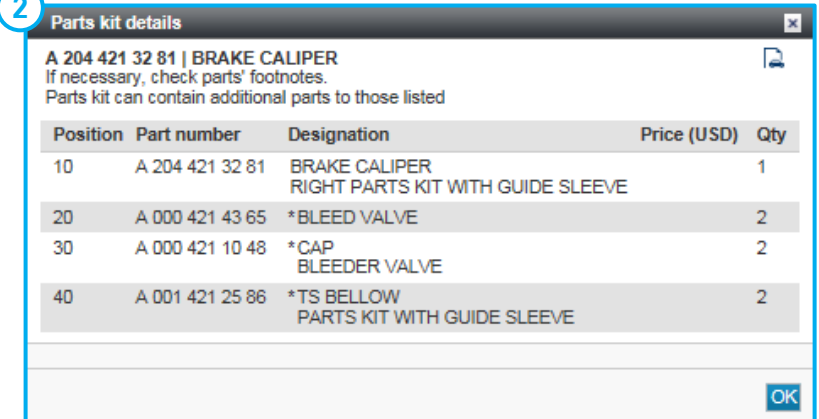

Detailed information on item number - Display of second-line part (ES1: 90) for part

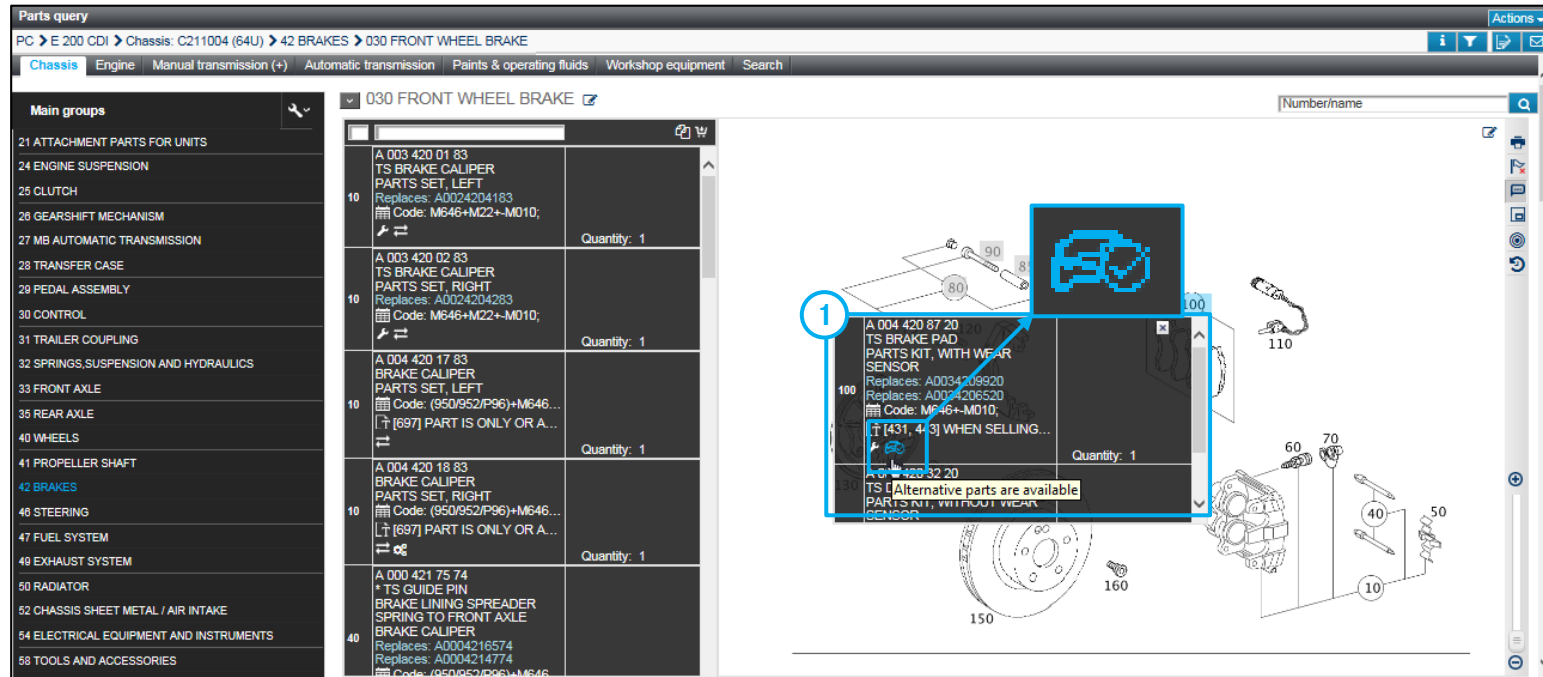

1 **Select second-line part**
If a second-line part (ES1: 90) is available for a part, this is indicated by a new icon.

2 **Second-line part details**
Quick overview of the alternative parts included. Parts can be selected and placed in the shopping cart.

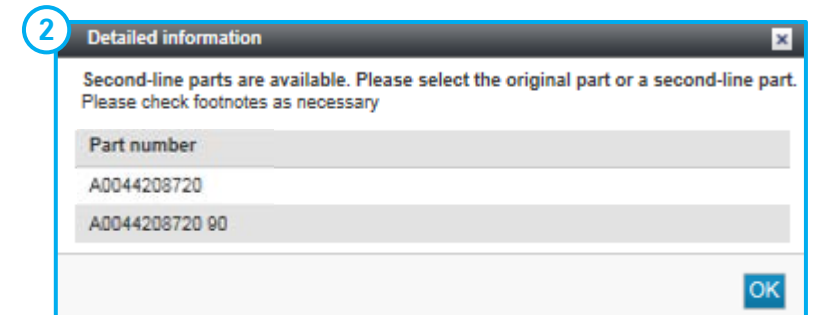

Note: If a part is both an 80 remanufactured part and a 90 second-line part, the 80 information has priority and the old icon is retained.

Additional information about vehicle and notes

Note on picture chart

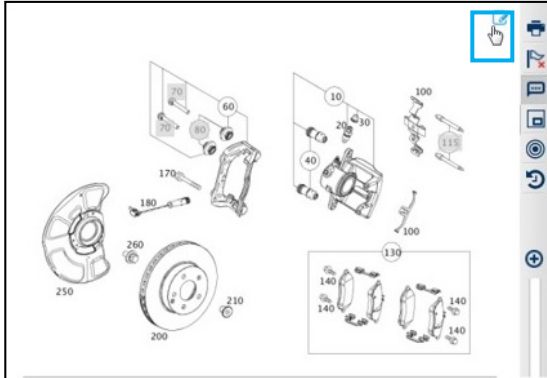

Create **note** on entire picture chart.

Note on part

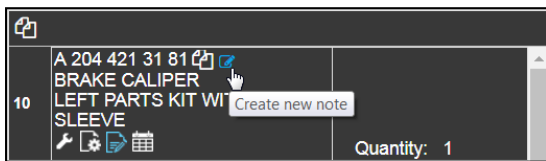

Create a **note** on a particular part.

Note on data card

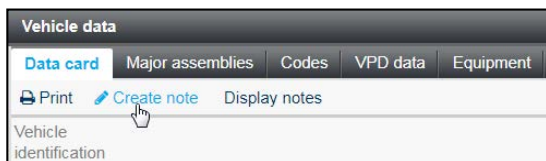

Display notes



Show additional information



Detailed view:



The **additional information** consists of the six-digit model designation, the sales code and a brief description - among other info. Clicking on **OK** closes the window again.

Create a **note** on a main group or subgroup

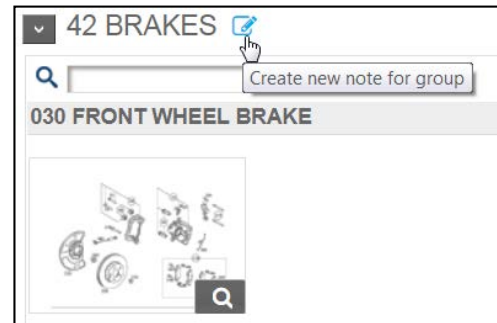

Detailed view:

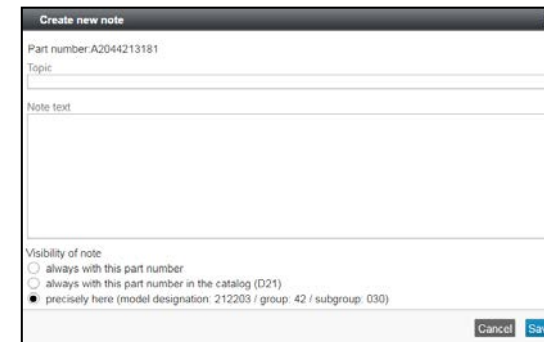

Additional information about vehicle – Filters

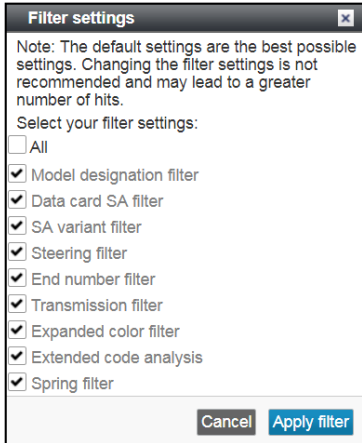

The **Filter Settings** window displays the filter settings and these can be changed if necessary. The filter is brought up via the **Show Filter** button.

Individual filters can be switched on and off via the checkboxes.

All grayed out filters cannot be applied in the current context. A change to the filters is applied to the current navigation context with "Apply filter".

The new results are displayed directly afterwards.

The display and associated number of hits changes depending on the number of filters active "All", "Some", "None".



Note: All of the settings in the **Show filter** window are temporary. This means that the settings are only valid for the active vehicle data.

If parts identification is then carried out with other vehicle data, the default filters are automatically activated.

Changing the filter settings is not recommended because the best possible settings are activated by default.

Filter symbol

The filter symbol appears as follows depending on the filter settings:

-  The default filter is active.
-  Individual filters have been changed.
-  No filters are active.

Show filter



The parts search function allows filtering of the results. The possible filters are determined when the VIN is supplied and are all activated initially to provide the most specific (low) number of hits.

Change filter

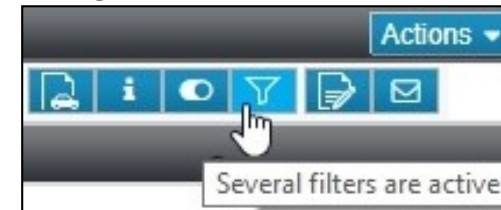

Not all filters are possible depending on the context. Deselecting filters changes the display when the cursor rolls over the button.

Delete filter



If all filters are deselected, all of the parts which can be installed on the vehicle are displayed.

Additional information about vehicle – Show vehicle



Data card

Information from the data card is required for correct parts identification (e.g. checking footnotes, validities, codes, SAs, installation kits etc.). The prerequisites are that the vehicle must be **identified with a complete vehicle identification number** and the **data card must exist** in the system.

Major assemblies

	Major assembly number	Variant	Object number
Engine	65192430413878		A8510102343
Transmission	72264608318185		2122700600
Front axle, left	2123308305101029113878		
Front axle, right	2123308405101029113885		
Rear axle	21235019041070604004		
Integral carrier	2186280157001029310769		2186280157
Steering	2124603000991029410295		2124603000

The "Major assemblies" tab lists all associated major assembly numbers, their variants and object numbers.

SAA numbers

Number	Group	Designation	Quantity
00000000			1
08618492	[31, 42, 52, 54]	ANBAUTEILE BEI VERSETZTEM BATTERIETRAEGER	1
50400206	[33, 35]	SV DIFFERENTIALSPERRE	1
50400304	[33, 35]	SV KUPPLUNGSFLANSCH	1

SAA numbers stand for **variant parts lists**. They designate the parts list of a particular product or major assembly variant and can be searched for/filtered directly via an input field.

Codes

Code	Designation	Code type
062	Packet 04	sales
108	STEUERCODE VERTRIEB	sales
110	KRAFTSTOFFMENGE FUER SELBSTABHOLER	production
197U	OBSIDIANSCHWARZ - METALLICLACK	sales
202B	BEDIENUNGSANLEITUNG U WARTUNGSHFT-DEUTSCH	partIdent

The "Codes" tab lists all **equipment** and **special equipment codes**. It is possible to filter special equipment by code or designation.

Search function – Simple search

Parts query

PC > E 250 CDI / D > Chassis: WDD 212203 1A 360436 (D21)

Chassis Engine Automatic transmission Paints & operating fluids Workshop equipment Search

Main groups

- 21 ATTACHMENT PARTS FOR UNITS
- 24 ENGINE SUSPENSION
- 25 CLUTCH
- 26 GEARSHIFT MECHANISM
- 27 MB AUTOMATIC TRANSMISSION
- 29 PEDAL ASSEMBLY
- 30 CONTROL
- 31 TRAILER COUPLING
- 32 SPRINGS,SUSPENSION AND HYDRAULICS
- 33 FRONT AXLE
- 35 REAR AXLE
- 40 WHEELS
- 41 PROPELLER SHAFT
- 42 BRAKES
- 48 STEERING
- 47 FUEL SYSTEM
- 49 EXHAUST SYSTEM
- 50 RADIATOR
- 52 CHASSIS SHEET METAL / AIR INTAKE
- 54 ELECTRICAL EQUIPMENT AND INSTRUMENTS
- 58 TOOLS AND ACCESSORIES
- 60 BODY SHELL
- 61 SUBSTRUCTURE

Search - 29 Results

Model designation	Part	Group
212203 F	A2037580058 MERCEDES STAR -	52 - CHASSIS SHEET METAL / AIR INTAKE 135 - AIR INTAKE, DIESEL VEHICLES
212203 F	A0008171010 MERCEDES STAR -	88 - ATTACHMENT PARTS 135 - RADIATOR GRILL
212203 F	A2218800089 MERCEDES STAR -	88 - ATTACHMENT PARTS 120 - ENGINE HOOD
212203 F	A2128170118 MERCEDES STAR -	74 - REAR-END DOOR 045 - REAR PANEL DOOR ATTACHMENT...
212203 F	A2128103001 MERCEDES STAR -	98 - ACCESSORIES 020 - OUTSIDE ATTACHMENT PARTS
212203 F	A2188179100 MERCEDES STAR -	98 - ACCESSORIES 020 - OUTSIDE ATTACHMENT PARTS
212203 F	A2188105800 MERCEDES STAR -	98 - ACCESSORIES 020 - OUTSIDE ATTACHMENT PARTS
212203 F	A2188108300 MERCEDES STAR -	98 - ACCESSORIES 020 - OUTSIDE ATTACHMENT PARTS
212203 F	A2218700089 HEADPHONES -	82 - ELECTRICAL SYSTEM 327 - REAR ENTERTAINMENT

- 1 Enter the part number or part designation in the input field and then click on the **Search** button.

All the search hits for your input appear in a separate window.

Note: The system inserts wildcards before and after your input in order to increase the probability of hits.

You can deactivate this in your user preferences.

Note: If there are no hits in a search for a part, the message "No parts found for search text ..." appears.

Clicking on the part number takes you **automatically to the picture chart** and the corresponding item number.

- 2

Search function – Advanced part search

The screenshot shows the Mercedes-Benz parts search interface. The top navigation bar includes 'Chassis', 'Engine', 'Automatic transmission', 'Paints & operating fluids', 'Workshop equipment', and 'Search'. The 'Search' tab is active. Below the navigation bar, there are tabs for 'Parts', 'Workshop equipment', 'Paints and operating fluids', and 'SA/Construction Kit'. The search input field contains 'pad' and the 'Search' button is highlighted. Below the input field, there is a 'Group' dropdown menu set to '42', and two checkboxes: 'including SAs' (unchecked) and 'including major assemblies' (unchecked). A note below the checkboxes reads: 'Please enter a part number or designation. You can use * as a wild card.'

The search results are displayed in a table with the following columns: 'Model designation', 'Part', and 'Group'. The results are as follows:

Model designation	Part	Group
212203 F	A0064202820 DISK BRAKE PAD -	42 - BRAKES 030 - FRONT WHEEL BRAKE
212203 F	A0054201020 TS DISK BRAKE PAD -	42 - BRAKES 030 - FRONT WHEEL BRAKE
212203 F	A0054201320 TS DISK BRAKE PAD -	42 - BRAKES 030 - FRONT WHEEL BRAKE
212203 F	A0054209420 TS DISK BRAKE PAD -	42 - BRAKES 045 - REAR WHEEL BRAKE
212203 F	A0074206820 TS DISK BRAKE PAD -	42 - BRAKES 045 - REAR WHEEL BRAKE
212203 F	A0074205820 TS DISK BRAKE PAD -	42 - BRAKES 030 - FRONT WHEEL BRAKE
212203 F	A0074207520 TS DISK BRAKE PAD -	42 - BRAKES 030 - FRONT WHEEL BRAKE
212203 F	A0054207920 TS DISK BRAKE PAD -	42 - BRAKES 045 - REAR WHEEL BRAKE
212203 F	A0054209320 TS DISK BRAKE PAD -	42 - BRAKES 045 - REAR WHEEL BRAKE

Under the **Search** tab, you have the option of performing an advanced search by selecting various filter options.

In addition to a basic search entry, you can apply the following filters:

Group

Filters out all parts which are not contained in the specified group ID. A maximum of one group ID can be specified.

Additional information for designation

Filters out all parts which do not contain the specified additional information.

Including SAs

This checkbox activates/deactivates the inclusion of SAs.

Including major assemblies

This checkbox activates/deactivates the inclusion of major assemblies.

Search function – Advanced part search without vehicle context

The screenshot shows the 'Parts query' interface with the 'Part search' field highlighted. Below it, a 'Search' dialog box is open, displaying a table of search results for the part number A 007 420 75 20.

Model designation	Part number	Designation
C172	A 007 420 75 20	TS DISK BRAKE PAD
C204	A 007 420 75 20	TS DISK BRAKE PAD
C207	A 007 420 75 20	TS DISK BRAKE PAD
C212	A 007 420 75 20	TS DISK BRAKE PAD
C218	A 007 420 75 20	TS DISK BRAKE PAD

The **parts search** function also gives you the option of performing a parts search without vehicle context.

Enter a **part number** to do so.

A new dialog window opens. Here you can select a **model designation for your part number** by clicking on the **Type/SA number**.

Search function – Advanced workshop equipment search

PC > E 250 CDI / D > Chassis: WDD 212203 1A 360436 (D21) > 42 BRAKES > 030 FRONT WHEEL BRAKE

Chassis Engine Automatic transmission Paints & operating fluids Workshop equipment **Search**

Parts **Workshop equipment** Paints and operating fluids SA/Construction Kit

Part number W 0?? 58 8 00 72 ?*

Designation

Note: *, ? and blank spaces will be accepted as wildcard characters for part numbers. Inquiry does not use vehicle data.

Search

PC > E 250 CDI / D > Chassis: WDD 212203 1A 360436 (D21) > 42 BRAKES > 030 FRONT WHEEL BRAKE

Chassis Engine Automatic transmission Paints & operating fluids **Workshop equipment** Search

3 entries have been found for the W0**5880072** / search parameter.

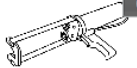
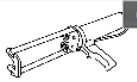
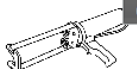
Part number	Designation/additional information	Validities	Groups	Kit	Image
W 000 588 00 72 00	Sealing and corrosion protection gun Purpose: Double cartridge gun for processing two-component material of double cartridges with Mercedes-Benz object number. Procurement information: This criteria catalog is intended as an aid for selecting one of the commercially available variants of a workshop equipment item. It merely describes the minimum requirements for fulfilling the Mercedes-Benz standard. No reference is therefore made to manufacturer-specific equipment or items.	T (Light vans): 900, 906, 907, 910 T (Passenger car): 166, 177, 204, 205, 207, 209, 212, 213, 217, 218, 221, 222, 231, 238, 253	63, 65, 77, B 97		
W 000 588 00 72 00	Sealing and corrosion protection gun Purpose: Double cartridge gun for processing two-component material of double cartridges with Mercedes-Benz object number. Procurement information: This criteria catalog is intended as an aid for selecting one of the commercially available variants of a workshop equipment item. It merely describes the minimum requirements for fulfilling the Mercedes-Benz standard. No reference is therefore made to manufacturer-specific equipment or items.	T (Light vans): 900, 906, 907, 910 T (Passenger car): 118, 166, 177, 204, 205, 207, 209, 212, 213, 217, 218, 221, 222, 231, 238, 247, 253	63, 65, 77, B 97		
W 000 588 00 72 00	Sealing and corrosion protection gun Purpose: Double cartridge gun for processing two-component material of double cartridges with Mercedes-Benz object number. Procurement information: This criteria catalog is intended as an aid for selecting one of the commercially available variants of a workshop equipment item. It merely describes the minimum requirements for fulfilling the Mercedes-Benz standard. No reference is therefore made to manufacturer-specific equipment or items.	T (Light vans): 900, 906, 907, 910 T (Passenger car): 118, 166, 167, 177, 204, 205, 207, 209, 212, 213, 217, 218, 221, 222, 231, 238, 247, 253	63, 65, 77, B 97		

Parts from the "Tools" category can be searched for and filtered using this **search** function.

The following filter options are available:

Part number

The part numbers for workshop equipment are made up of separate sections.

Each part number is structured as follows:

"W" + "XXX" + "58" + "X XX XX XX".

A free-text search for the part number can be carried out using wild cards (*;?; space).

Designation

Filters out all tools which do not contain the specified designation.

Note:

The advanced "Workshop equipment" search does not use vehicle data.

Search function – Advanced search – SA/construction kit

Parts query

Trucks > 7.. L > Chassis: WDB 967021 10 237938 (S10)

Chassis Engine Manual transmission Front axle Rear axle Exhaust system Body Paints & operating fluids Workshop equipment Search

Parts Workshop equipment Paints and operating fluids SA/Construction Kit

Z 504142 / 37 Search

including major assemblies

Please enter an SA number (e.g. 508093/01). You can use * as a wild card.

Parts query

Trucks > 7.. L > Manual transmission: 715086 G2 007895 (G10) > 26 TRANSMISSION; SIX-SPEED > 150 GEAR SHAFTS AND GEARS

Chassis Engine Manual transmission Front axle Rear axle Exhaust system Body Paints & operating fluids Workshop equipment Search

Main groups

25 CLUTCH

26 TRANSMISSION; SIX-SPEED

150 GEAR SHAFTS AND GEARS

Part Number	Description	Quantity
A 018 981 96 10	* NEEDLE BEARING 3RD SPEED [066, 067]	1
A 018 981 98 10	* NEEDLE BEARING 3RD SPEED [066, 067]	1
A 023 981 38 10	* NEEDLE CAGE 3RD SPEED [066, 067]	1
A 070 262 15 13	* IDLER GEAR 3RD GEAR 3RD SPEED [066, 067]	1
A 695 262 00 13	* IDLER GEAR 3RD GEAR 3RD SPEED [066, 067]	1
A 695 262 01 13	* GEARWHEEL 3RD SPEED [066, 067]	1

Image ID: drawing_B26150000649

26 TRANSMISSION; SIX-SPEED

100 TRANSMISSION CASE AND COVER 150 GEAR SHAFTS AND GEARS 200 SHIFTING RAIL... 250 SHIFTING ROD...

This **Search** can be used to find variant parts lists/construction kits.

When an **SA number** is entered and a subgroup is selected, only those parts that match the entered SA number are displayed.

Note: The thumbnails of an entire **Design Group (DG)** can be scrolled through very quickly using the arrow keys on the keyboard.

It is easy to switch between the main groups and subgroups, and only those parts that match the SA number are displayed. This means that the filtering of the parts is applied to the vehicle as a whole.

Note: This search can only be performed for specific vehicles.

Note: If there are subgroups with multiple pages, it may be the case that the result of your SA search is not displayed directly and is shown on one of the following picture charts. In this case, scroll to the following pages using the arrow buttons

Search function – Advanced search – Model designation for major assembly

Parts query

Vehicles and major assemblies | Paints & operating fluids | Search in SA | Workshop equipment | Parts for model designation | !Baumuster zum Aggregat

!Baureihe oder Baumuster

717417 Search

Vehicles and major assemblies | Paints & operating fluids | Search in SA | Workshop equipment | !Baumuster zum Aggregat

!Baureihe oder Baumuster

717417 Search

!Trefferliste für Fahrzeuge mit Aggregat 717417

!Fahrzeug Baumuster	Designation
> 170435	SLK 200
> 202018	C 180
> 202020	C 200
> 202022	C 220
> 202023	C 230
> 202078	C 180 Station Wagon
> 202080	C 200 Station Wagon
> 202083	C 230 Station Wagon
> 202125	C 250 Diesel
> 208335	CLK 200
> 208435	CLK 200 Cabriolet
> 210010	E 250 D

!Fahrzeug Baumuster	Designation
> 170435	
> 202018	
> 202020	
> 202022	
> 202023	
> 202078	C 180 Station Wagon
> 202080	C 200 Station Wagon

Selection

45H

45W Valid for JP

Select

This **Search** can be used to find vehicle model designations in which a certain major assembly is installed.

When the **model series** or the **model designation** (3 to 6 digits) is entered and the desired **model designation** 1 and, if necessary, a **catalog** 2 is selected, only those parts that match the entered search criteria are displayed.

Printing out labels for special tools

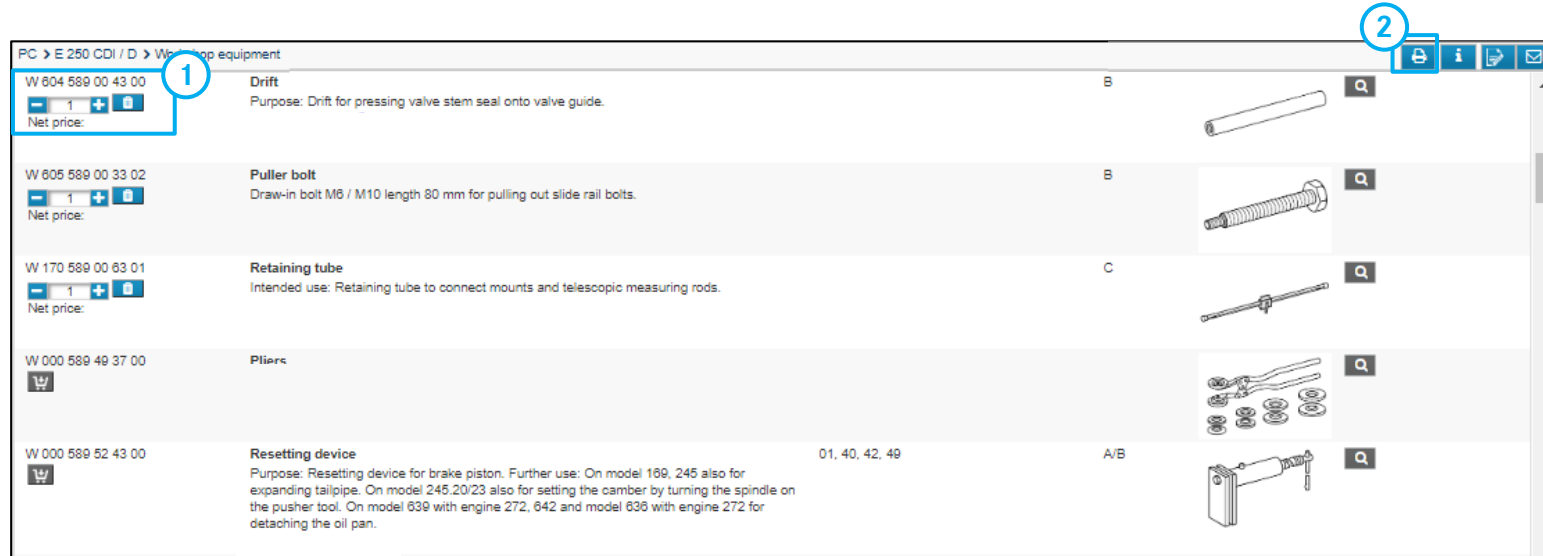

1 Place special tools in shopping cart

To print labels for special tools, enter a model designation or a VIN under the **workshop equipment** tab. After entering your vehicle data, the labels for special tools are displayed. Now place the desired special tools in the **shopping cart** and then click on the **Print** button.

2 Print labels

3 Label selection

A dialog appears and you can select the desired **label items**. After selection, these are printed out by clicking on **Print**.

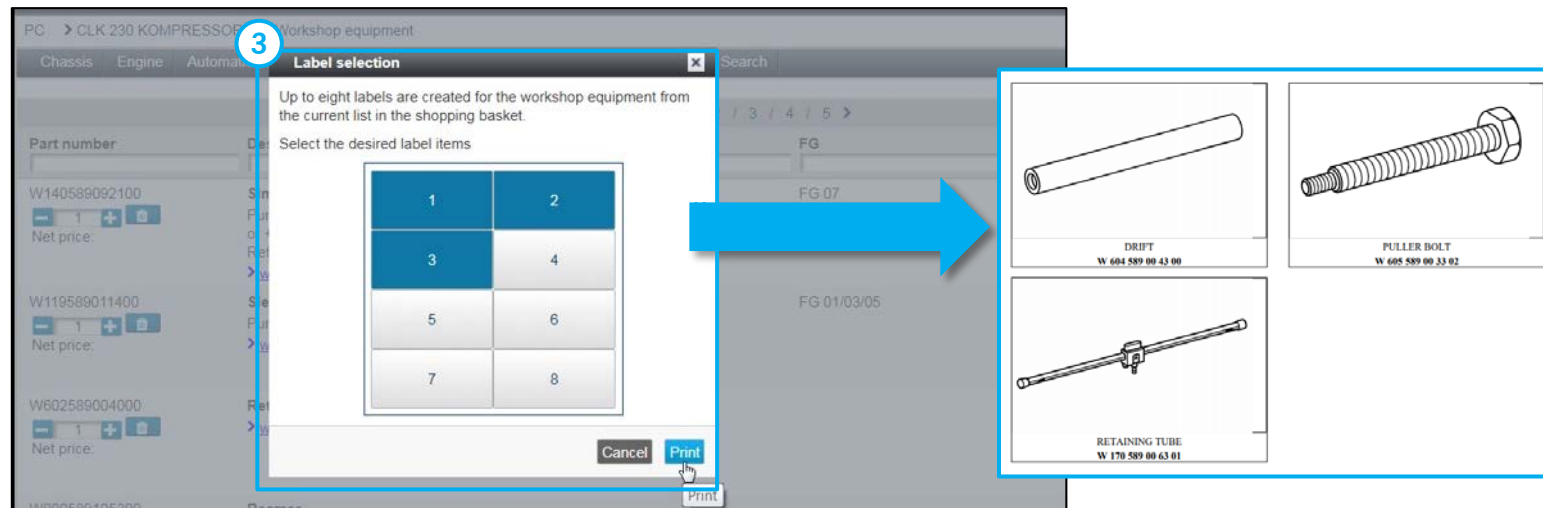

Overview of user settings

The screenshot shows the 'User settings' dialog box with the following sections and settings:

- Prices and availability** (Section 1): No settings found for you.
- Copy part numbers** (Section 2):

Setting	Value
Remove first character when copying part numbers	<input type="checkbox"/>
Separator between copied part numbers	<input type="checkbox"/>
Automatically copy selected parts to clipboard	<input type="checkbox"/>
- Picture chart and parts list** (Section 3):

Setting	Value
Display flyouts in picture chart	<input checked="" type="checkbox"/>
Only show marked parts	<input type="checkbox"/>
Hide parts list	<input checked="" type="checkbox"/>
Hide replaced parts	<input checked="" type="checkbox"/>
Code and footnotes as text in picture chart	<input checked="" type="checkbox"/>
Display WIS link in parts list	<input checked="" type="checkbox"/>
- Navigation and search** (Section 4):

Setting	Value
Quick search with wildcards	<input checked="" type="checkbox"/>
Dynamic main groups	<input type="checkbox"/>
Show images in subgroup selection	<input checked="" type="checkbox"/>
Subgroup display	List
VIN search range	VIN
- Other settings** (Section 5):

Setting	Value
Show transparent mask during waiting times	<input type="checkbox"/>
Delay in interface blocking for long-running actions (ms)	750
Show listed selection of model designations (change is activated for new process)	<input type="checkbox"/>

- ① Activation and deactivation of price and availability displays
- ② Options for copying part numbers
- ③ Display options for picture chart and parts list
- ④ Navigation and search settings
- ⑤ General settings.

Further details can be found in the user documentation

Note:

If you do not need the price and availability query function, deactivate it. The deactivation of queries in the DIMS and/or DMS improves performance. This is why the items listed under ① are deactivated by default; they can, however, be activated if required.

Recording of faults and requirements

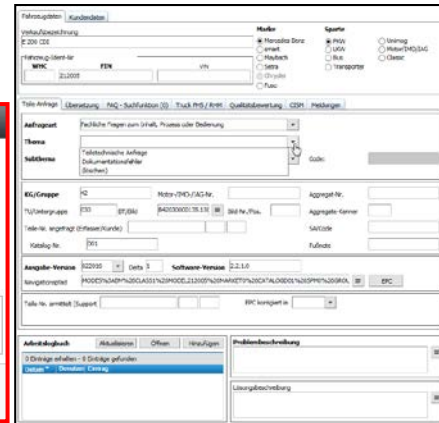

Record queries about Parts Information:

1. Bring up XSF via letter symbol
2. Complete and submit XSF ticket



The existing support processes also apply to Parts Information in future

Record other error messages in the parts search function:

1. Detailed view of error message  "Text of error message" 

2. Bring up XSF from error message

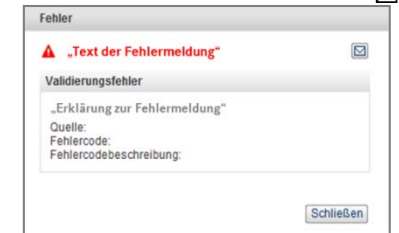



Committed to Win. Together.